

**Goldfern**Mobility™

[www.goldfernmobility.co.nz](http://www.goldfernmobility.co.nz)



# **Merits Yoga Portable Travelling Scooter**

## Assembly & User Manual

**MMS-S542-WR**

Read manual carefully before use.

Read this manual before  
using the Scooter and  
save for future reference.

### ■ **Indications For Use**

The Merits Yoga Power Scooter, S542, is to provide mobility to adult persons limited to a sitting position and capable to operate a few simple controls.

# Table of Content

## **Introduction**

Practice before Operating -----	4
---------------------------------	---

## **Safety Instructions**

Safety Considerations -----	6
-----------------------------	---

Driving Outdoors -----	9
------------------------	---

Use caution when driving on hills -----	11
---	----

## **Familiarize Yourself with your Scooter**

The Battery -----	13
-------------------	----

Feature Diagram -----	14
-----------------------	----

Terminology -----	15
-------------------	----

Fold and Unfold your scooter -----	16
------------------------------------	----

Install and Remove Battery Pack -----	24
---------------------------------------	----

## **Operating your Scooter**

Controls -----	27
----------------	----

Seat -----	29
------------	----

Tiller Angle Adjustment -----	30
-------------------------------	----

Cleaning and Disinfection -----	31
---------------------------------	----

## **Technical Specification-S542**

IEC Symbols -----	32
-------------------	----

Warranty -----	33
----------------	----

Welcome aboard your new scooter, and thank you for choosing our product. Please read this manual carefully, and follow all instructions before attempting to operate your scooter for the first time. If there is anything in this manual that you do not understand, or if you require additional assistance for setting up your scooter, please contact your local dealer.

This latest model is designed for specific practical user needs, combining solid, rugged construction, and modern high-tech electronics, to enhance safety and performance.

With a state-of-the-art, programmable electronic control system, your scooter can be programmed and adjust within a given range of its performance characteristics, to suit your individual needs. The controller is set up at the factory to give the scooter nominal operating performance characteristics.

After becoming familiar with the basic operation of the scooter, you may wish to customize the settings to fit your own personal preferences. A wide range of customization options can be adjusted such as acceleration, deceleration, maximum speed, turning speed, safety controls, and so on. Contact your local dealer for advice on additional equipment you may need.

Have your scooter checked regularly by your local dealer is the best way to ensure smooth operation, and safety.

This manual provides users practical tips and information on safety issues, operation, and maintenance. Please read it very carefully to ensure your maximum enjoyment and to fully benefit from your independence and mobility.

Whenever special advice or attention is needed, please do not hesitate to contact your local dealer, who has the tools and know-how to provide expert servicing for your scooter.

Your satisfaction and opinions are highly valued by both your local dealer and our company. Please be sure to fill out the enclosed guarantee form, and return it to your local dealer. The information is necessary for providing you with the best service, and to be sure all of your needs are met.

Failure to follow these instructions may result in damage to the scooter or serious injury.

## ■ Practice Before Operating

Find an open area such as a park and have an assistant to help you practice until you have confidence operating this vehicle.

Make sure that the unit is off before getting in or out of the it. Set the speed control knob according to your driving ability.

**We recommend that you keep the speed at the slowest position (fully counter-clockwise) until you are familiar with the driving characteristics of this vehicle.**

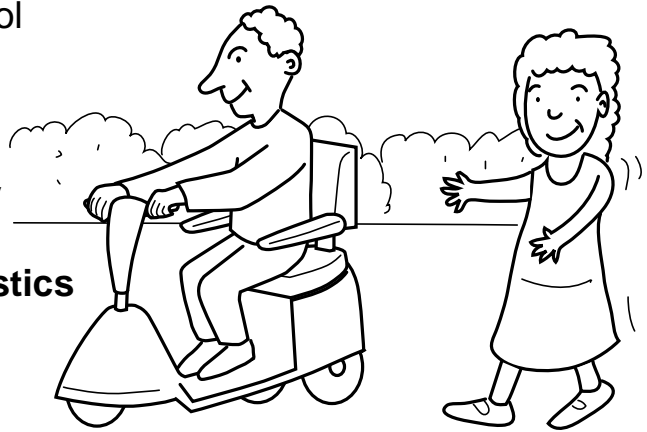

Stop, forward, and reverse operation practice

Push the lever backward on the **right** side to move **forward**

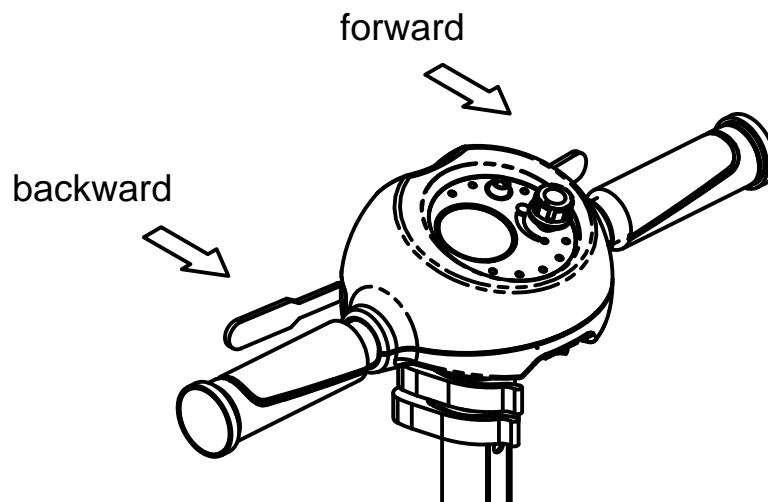

Push the lever backward on the **left** side to move **backward**

## Getting familiar with this vehicle

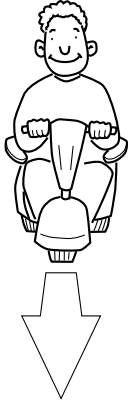

**First, practice moving forward.  
Be sure to set the speed to the lowest setting.**

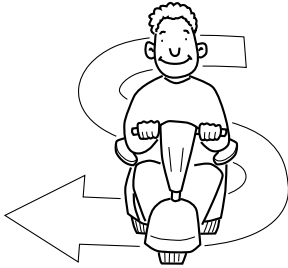

**After becoming familiar with moving forward,  
practice making "S" turns.**



**Once you are familiar with "S" turns, practice  
moving in reverse. Note that any speed control  
setting, the vehicle moves more slowly in reverse  
than forward**

## ■ Safety Considerations

**DO NOT** do any of the following



**NO!**  
Do not carry any passengers



**NO!**  
Do not drive across a slope



**NO!**  
Do not drink and drive  
Consult your physician to determine if your medications impair your ability to control this vehicle



**NO!**  
Do not tow a trailer



**NO!**  
Do not turn on or use hand-held personal communication devices such as citizens band(CB) radios and cellular phones



**NO!**  
Do not make turns at high speed. Making turns at high speed is very dangerous and may cause the vehicle to tip over.

This vehicle has an immunity level of 20 V/m which should protect it from Electromagnetic Interference(EMI) from Radio Wave Sources. The rapid development of electronics, especially in the area of communications, has saturated our environment with electromagnetic (radio) waves that are emitted by television, radio and communication signals. These EM waves are invisible and their strength increases as one approaches the source. All electrical conductors act as antennas to the EM signals and, to varying degrees, all power wheelchairs and scooters are susceptible to electromagnetic interference (EMI). This interference could result in abnormal, unintentional movement and/or erratic control of the vehicle. The United Statement be incorporated to the user's manual for all electric scooter:

Powered wheelchairs and electric scooters(in this text, both will be referred to as powered wheelchairs) may be susceptible to electromagnetic interference(EMI), which is interfering electromagnetic energy emitted from sources such as radio stations, TV stations, amateur radio (HAM) transmitters, two-way radios and cellular phones. The interference (from radio wave sources) can cause the powered wheelchair to release its brakes, move by itself or move in unintended directions. It can also permanently damage the powered wheelchair's control system. The intensity of the EM energy can be measured in volts per meter (V/m). Each powered wheelchair can resist EMI up to a certain intensity. This is called the "immunity level." The higher the immunity level, the greater the protection. At this time, current technology is capable of providing at least 20 V/m of immunity level which would provide useful protection against common sources of radiated EMI.

Following the warnings listed below should reduce the chance of unintended brake release or powered wheelchair movement that could result in serious injury:

- 1) Do not turn on hand-held personal communication devices such as citizens band (CB) radios and cellular phones while the powered wheelchair is turned on.
- 2) Be aware of nearby transmitters such as radio or TV stations and try to avoid coming close to them.

- 3) If unintended movement or brake release occurs, turn the powered wheelchair off as soon as it is safe.
- 4) Be aware that adding accessories or components, or modifying the powered wheelchair, may make it more susceptible to interference from radio wave sources. (Note: there is no easy way to evaluate their effect on the overall immunity of the powered wheelchair).
- 5) Report all incidents of unintended movement or brake release to the powered wheelchair manufacturer, and note whether there is a radio wave source nearby.

**TURN OFF YOUR SCOOTER AS SOON AS POSSIBLE WHEN EXPERIENCING ANY OF THE FOLLOWING:**

1. Unintentional motions.
2. Unintended or uncontrollable direction.
3. Unexpected brake release.

The FDA has written to the manufacturers of power wheelchairs, asking them to test their new products to be sure they provide a reasonable degree of immunity against EMI. The letter says that powered wheelchair should have an immunity level of at least 20 V/m, which provide a reasonable degree of protection against the more common sources of EMI. The higher the level, the greater the protection.

## ■ Driving Outdoors

When you are on the road, please pay attention to the following:

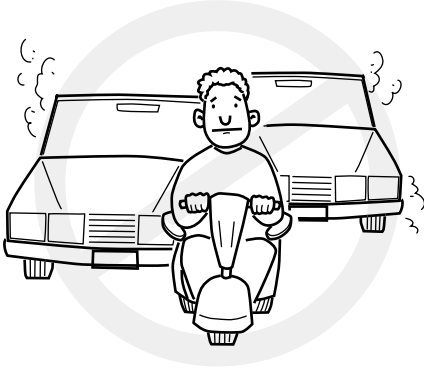

**NO!**

Do not drive in traffic.



**NO!**

Do not drive beside a river, port, or lake without a fence or railing.



**NO!**

If possible, do not drive during the rain.



**NO!**

If possible, do not drive during or on snow.



**NO!**

Do not drive off-road or on any uneven surfaced roads.



**NO!**

If possible, do not drive at night.



## **NO!**

Make sure that there are no obstacles behind you when in reverse.

We recommend to set up the speed knob at the lowest speed for reversing.



## **NO!**

Do not make sudden stops, weave erratically, or make sharp turns.



## **NO!**

Keep your arms on or inside the armrests and feet on the footrest at all time.



## **NO!**

Do not attempt to climb curbs greater that 1.5"(4cm).



## **NO!**

Do not attempt to cross over a gap greater that 3"(7.5cm).

## ■ Use caution when driving on hills

Driving on hills is more dangerous than on level surfaces. If you fail to heed these warnings, a fall, tip-over or loss of control may occur and cause severe injury to the vehicle user or others.



**NO!**

**Do not attempt to climb a hill greater than 6°**



**NO!**

**Do not reverse while driving up a hill.**

Forward only. If you reverse while moving up a hill, it may cause the vehicle to tip over.



**NO!**

**Do not attempt to drive across a sloping surface greater than 3°**

Driving across a slope greater than 3° is very dangerous and may cause the vehicle to tip over.



**NO!**

**Use caution when driving over soft, uneven or unprotected surfaces such as grass, gravel and decks.**

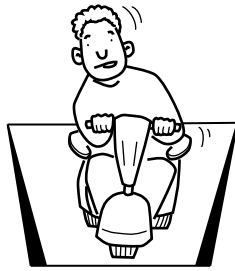
**NO!**

**Do not lean on one side while stopping on a hill.**  
Lean on one side may cause the vehicle to slide down the hill.

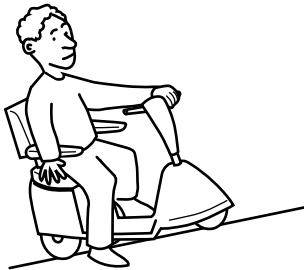
**NO!**

**Do not get in and off on a hill.**  
Always stop on the level surface to get in and get out of the vehicle.

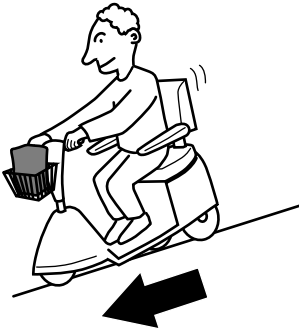
**NO!**

**Do not load or carry heavy items in the basket while driving down hill.**

**YES!**

**Use low speed while driving down hill.**  
When going down hill, the tiller will become harder to reach and handle. When braking while moving down hill, the scooter will take longer to come to a complete stop.

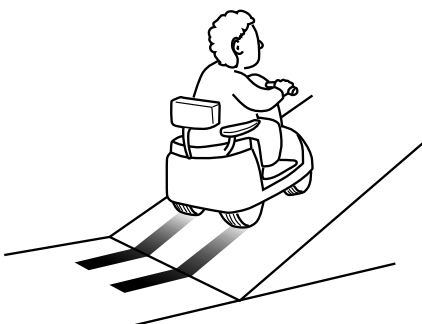
**YES!**

**Always climb or descend gradients perpendicular to the slope or ramp.**

## ■ The Battery

Your scooter is equipped with a removable battery pack, which contains one maintenance free 24v Lithium battery. This battery require no maintenance other than ensuring that it is properly charged. If other battery is used, check with your battery supplier for proper battery care and maintenance instructions.

### Charging the Battery

Because your battery may only has a partial charge when you first receive your scooter, you may not experience full riding time until you have fully charged it. Your scooter is equipped with an battery charger. Charging your battery as specified below will ensure maximum life, power, and range.



**WARNING : Use of a non-grounded receptacle could result in an electric shock**

### Charging Battery

1. Turn off the power on the scooter.
2. Slide away the cover of the battery receiver socket and insert the battery charger socket.
3. Do not switch on the battery charger until all the plugs are in position.
4. Battery charger when starting its charge will show an amber light. The charge is complete when the charging light turns to green.



battery charging Port

## ■ Feature Diagram

In this section, we will acquaint you with the many features of your foldable scooter and how they work. Upon receipt of your foldable scooter, inspect it for any damage. Your foldable scooter consists of the following components.



- |                                  |                            |
|----------------------------------|----------------------------|
| 1. Tiller                        | 10. Rear Shroud            |
| 2. Tiller Angle Adjustment Lever | 11. Pu Tyres (Front Wheel) |
| 3. Seat Ass'y                    | 12. Pu Tyres (Rear Wheel)  |
| 4. Anti-Tip Wheels               | 13. Locking Knob           |
| 5. Switch                        | 14. Battrey Holder         |
| 6. Wig-Wag Control Lever         | 15. Footrest Cover         |
| 7. Front Shroud                  | 16. Backup Battery Bag     |
| 8. Removable Battery Pack        | 17. Clamp                  |
| 9. Latch                         |                            |

## ■ Terminology

1. **Tiller** - Similar in operation to the handlebars of a bicycle, this device is used to steer the vehicle. It also contains the controls necessary to propel and control the vehicle.
2. **Tiller angle Adjustment Lever** - When pull, allows the tiller angle to be set for optimum driver comfort.
3. **Arm-Rests** - are width and angle adjustable. (see seating adjustments later in this manual).
4. **Anti-tip Wheels** - Positioned one each side of the vehicle at the rear, these wheels prevent a tip-over backwards.
5. **Switch** - This is used to turn vehicle power to ON and to OFF.
6. **Wig-Wag Control Lever** - This is used to control the speed and direction of drive.
7. **Removable Battery Pack** - This pack holds one 24 volt battery.

## ■ Fold and Unfold your scooter

This scooter can be folded for transportation or storage. Follow the procedures below to fold and unfold your scooter and transport it with care.

### Unfold Procedures



Avoid pinch points while folding and unfolding the scooter.

### Folding Procedures

Step 1: Release the Quick Clamps on the Tiller and retract the Tiller to its lowest position.



Step 2: Pull the lever on the top of the Gas Spring which is behind the Tiller. And let the Tiller to spring back to its forefront position.



Step 3: Fold the Backrest onto the Seat and fix it with the Backrest Clip on the side of the Seat.



Step 4: Pull back the Seat Lock on the side of the Seat to unlock the Seat. Flip the Seat up and start to fold the scooter.



Step 5: Keep on pushing down the Seat to retract the Front Wheel and Tiller until the scooter length is almost half of its original length.



Step 6: Hold the handle under the Seat and push the footrest with one foot to let the front portion of the scooter to move toward the Seat until the rear portion is locked with the front portion.



Step 7: Release the Quick Clamps on the Tiller and pull the Tiller up to an adequate position. You can either pull or push the scooter everywhere you like.



## Unfolding Procedures

Step 1: Release the Quick Clamps on the Tiller and retract the Tiller to its lowest position.

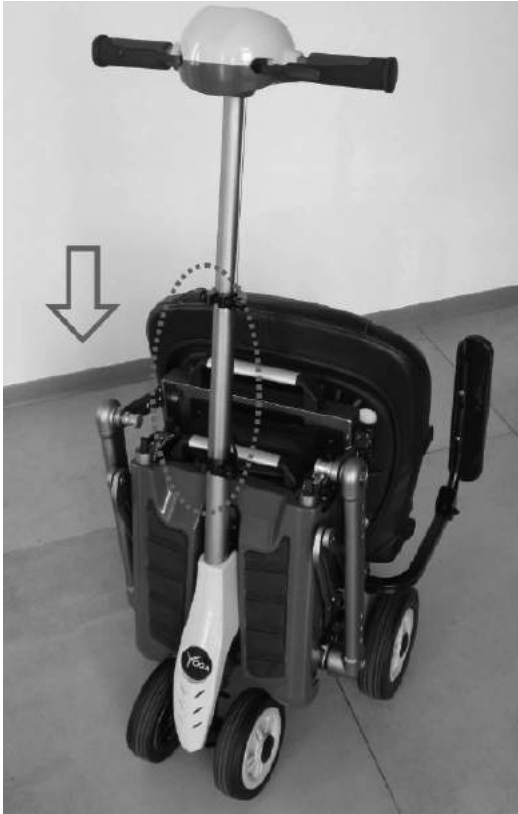

Step 2: Press down the Release Handle above the Rear Wheel to unlock the folded frame.



Step 3: Hold the Control Panel or Handle to push the Tiller and Front Wheel to move forward until it is hard to move it any further.



Step 4: Push down the Central Handle in the middle of the scooter with one hand and pull the lower edge of the backrest upward to rotate it to its sitting position with the other hand.



**Avoid pinch points while pushing down.**

Step 5: When the Central Handle is near to horizontal position, hold the Seat with two hands and keep on rotating it back to its normal position. A “click” sound will be heard when the Seat is locked into its normal riding position.



Step 6: Release the Backrest Clip and unfold the Backrest.



Step 7: Release the Quick Clamps on the Tiller and extend the Tiller to an adequate operating position.

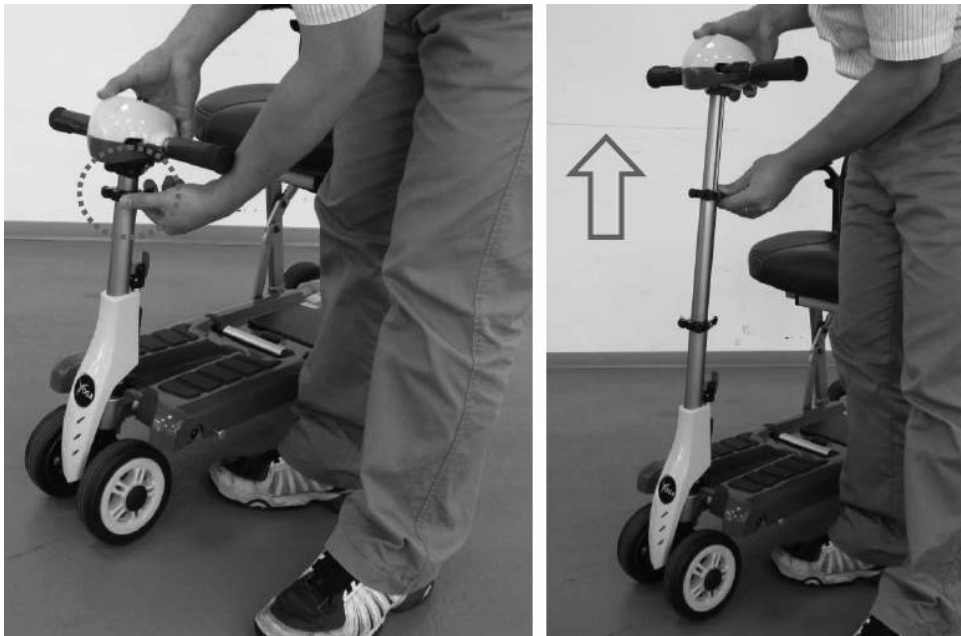

Step 8: Pull the handle on the top of the gas spring which is behind the Tiller with one hand. Hold and move the Tiller with the other hand to adjust the Tiller to a best operating angle.

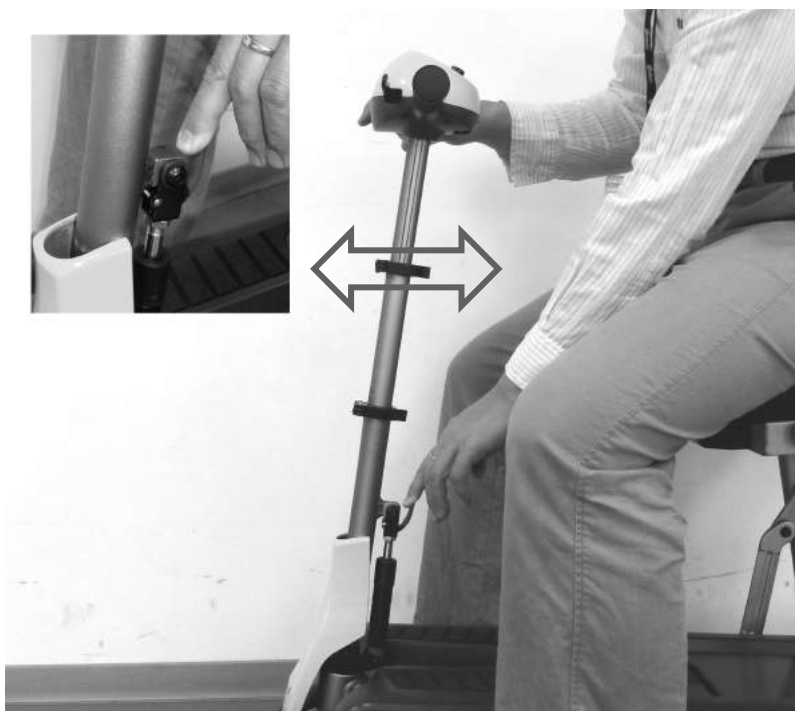

## ■ Install and Remove Battery Pack

Step 1: While removing the Battery Pack, slide and unlock the Battery Lock with your thumb.



Step 2: Pull and lift up the Battery Pack from the scooter.



Step 3: Remove the Battery Pack fully away from the Battery Recess on the scooter.



**Do not place metal objects over battery terminals.**

Step 4: While installing the Battery Pack, align the electrodes on the rear portion of the Battery Pack with the electrodes in the Battery Recess on the scooter.



Step 5: Release the Battery Pack to let it fall into the Battery Recess on the scooter. A “click” sound will be heard when the Battery Pack is locked into position.



Step 6: Switch on the scooter to check if the battery is installed correctly.



## ■ Controls

Only drive within your control limitations. Loss of control of your scooter could result in serious injury to yourself or others. If your speed becomes difficult to control, release the speed engager lever and your scooter will come to a complete stop. Only use the on/off switch to stop your scooter in an emergency.

### **Power Switch:**

Switch **ON** to power up your scooter.  
Switch **OFF** to power down your scooter.

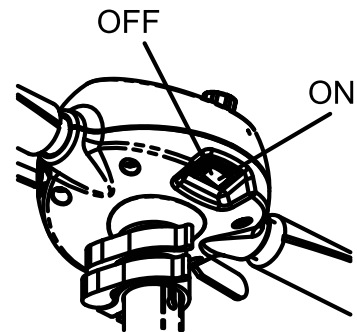

### **Speed Control:**

Speed Dial regulates the speed of the scooter. Start at the slowest speed until you feel confident controlling your scooter safely. Turn the speed dial counter-clockwise to decrease the speed. Turn the speed dial clockwise to increase the speed.

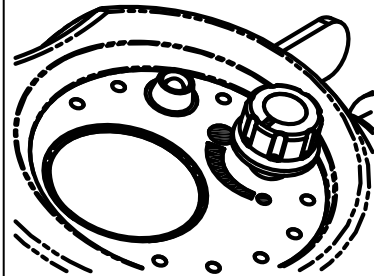

### **Forward / Reverse:**

To move forward push the lever on the right side.  
To move backwards push the lever on the left side.

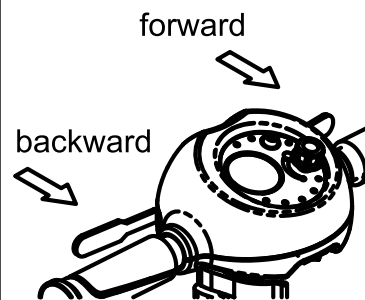

### **Battery Gauge:**

Indicates the charge level of the batteries. If the needle goes into the red area, the batteries need to be charged as soon as possible. If the needle is all the way to the right side of the green area, the batteries are fully charge. As the needle moves to the red area it indicates the depletion level.

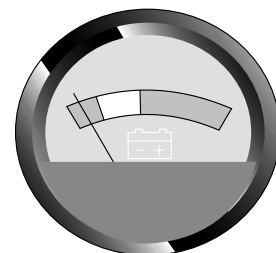

## Power eye:

When the scooter is on, and all conditions are normal, the Power Eye will be on. When there is some special situation that needs attention, the light will flash. See the reference chart below for the meanings of the different flashing patterns.

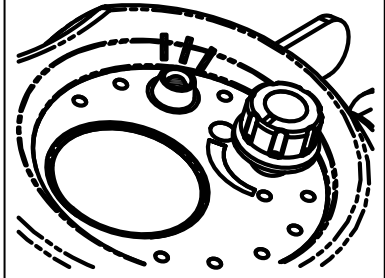

Number of Flashes	Meaning	Number of Flashes	Meaning
1	Battery needs recharging	6	Not in neutral at power up
2	Battery voltage too low	7	Speed pot error
3	Battery voltage too high	8	Motor volts error
4	Current limit time out	9	Other internal error
5	Brake fault	10	Controller over heat(C40 only)

**Brakes and Throttle control lever:** Whenever the speed engager lever is moved out of the neutral position, the electromagnetic brake will automatically release and your scooter will move. When the speed engager lever is released, it will return to the neutral position and the scooter will decelerate and come to a complete stop. The parking brake will then engage preventing further movement of your scooter. Your unit is equipped with a programmable controller that has a high peddle disable safety feature. This will prevent unexpected acceleration of the scooter, if the speed engage lever is activated the same time you turn the key "ON". To reset the controller, release the speed engage lever and turn the key "OFF" for a couple of seconds and then turn it back "ON".



**If your scooter ever moves in an unexpected manner, release the speed engager lever and turn off the power.**

## ■ Seat

### Backrest angle :

Backrest folds forward for ease of folding / storage.



### Armrest angle:

Flip the armrest up to expose the adjustable bolt .

Turn the bolt in to lower the angle of the armrest to your desire angle.



### Armrest width:

Locate the width socket set screw

(follow the armrest support down to the base of the seat).

Loosen the socket set screw by turning counter-clockwise.

Pull the armrest in or out to reach your desired position.

Tighten the width socket set screw.

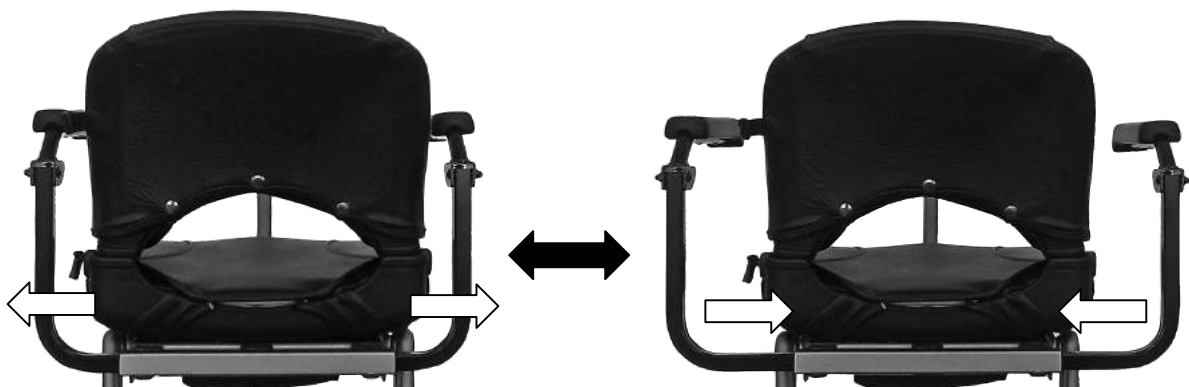

## Tiller Angle Adjustment:

The tiller angle adjustment lever allows you to position the tiller closer or further away for better access to the controls.

Sit on the seat before adjust the tiller angle.

Hold top of the tiller with one hand and pull down the lever with the other hand.

Adjust the angle of the tiller to a comfortable position.

Release the lever, test the tiller is set in position by attempting to push back and fore to push backward and forward.

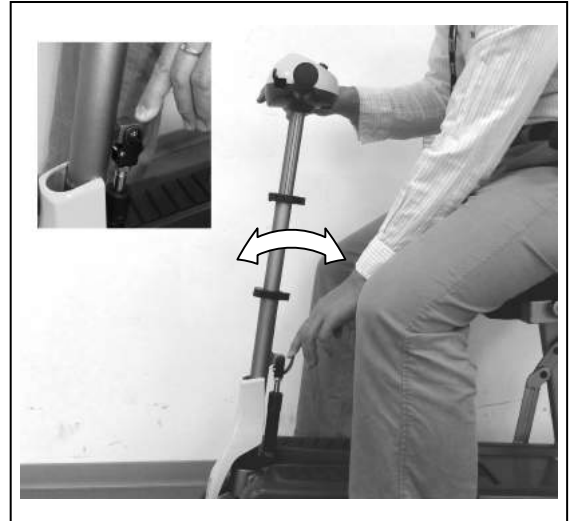

**Do not stand in front of the tiller while pulling the lever on the top of the gas spring. The tiller might hit your body while springing back.**

## Getting in and out:

Your scooter is designed to make getting in and out of the scooter as easy as possible. Make sure the scooter is on a level surface and the key switch is turned OFF. If necessary, raise the armrest to give you maximum space to transfer in or out of the seat. Once transfer is complete, return the armrest before operating the scooter.







**Never operate your scooter without your feet being placed on the scooter platform. Driving your scooter without your feet on the platform could cause serious bodily injury.**

### Cleaning and Disinfection:

- Use a damp cloth and mild, non-abrasive cleanser to clean the plastic and metal parts of your scooter. Avoid using products that may scratch the surface of your scooter.
- If necessary, clean your product with an approved disinfectant. Make sure the disinfectant is safe for use on your product before application.
- Follow all safety instructions for the proper use of the disinfectant and cleaning agent before applying it to your product. Failure to comply may result in skin irritation or premature deterioration of upholstery and/or scooter finishes.

### ■ Technical Specification - S542

Model No	S542
Overall Length	99cm (38.6")
Overall Width	53cm (20.9")
Maximum Rider Weight	114kg (250lbs)
Batteries	24V / 11.5AH
Battery Pack Weight	1.7kg (3.7lbs)
Ground Clearance	14cm (5.5")
Total Weight(w/o battery)	24kg (52.8lbs)
Maximum Range Up To	18km (11.25miles)
Maximum Speed	6kph (4 mph)
Front Wheel Size	6"PU Tire
Rear Wheel Size	7"PU Tire

IEC SYMBOLS	
	Caution, attention or consult accompanying documents.
	Alternating Current
	Type BF Equipment
	Double Insulation
	No Smoking or Naked Flames

Degree of protection against ingress of water is rated as IPx0.

## Warranty

Corporation warrants to the original purchaser of this wheelchair product that it is free of defect in material and workmanship and that, when operated within the guidelines and restrictions of this manual, will remain so free of defect in material and workmanship for a period of One (1) year from the original date of purchase.

Excluded from this warranty is failure due to negligence, abuse, accident, operation outside of rated limits, commercial or institutional use, damage / wear to upholstery or tires and improper maintenance or storage. The batteries for this wheelchair product are not supplied by Corporation; contact the battery manufacturer / supplier if warranty replacement is requested.

This wheelchair product must not be modified in any way without the express written consent of Corporation. Any such unauthorized modification could cause unreliable and / or unsafe operation and will void this warranty.

Where a failure occurs within the 1- year warranty period that is not excluded above, the failed components will be replaced with similar new or reconditioned components at sole option. Corporation will not be responsible for labor and / or shipping charges.

The foregoing warranty is exclusive and in lieu of all other warranties expressed or implied including, but not limited to, the implied warranty of merchantability and fitness for a particular purpose. Corporation will not be liable for any consequential or incidental damages whatsoever.



## Warranty Registration

### WARRANTY REGISTRATION

MODEL NO. \_\_\_\_\_

SERIAL NO. \_\_\_\_\_

DATE PURCHASED \_\_\_\_\_

NAME \_\_\_\_\_

ADDRESS \_\_\_\_\_

CITY \_\_\_\_\_ STATE \_\_\_\_\_ ZIP \_\_\_\_\_

DEALER NAME \_\_\_\_\_

STAMP

RETURN ADDRESS

\_\_\_\_\_  
\_\_\_\_\_  
\_\_\_\_\_



We wish you a safe and comfortable riding experience!



